

Radio Control Manual

Series L 40

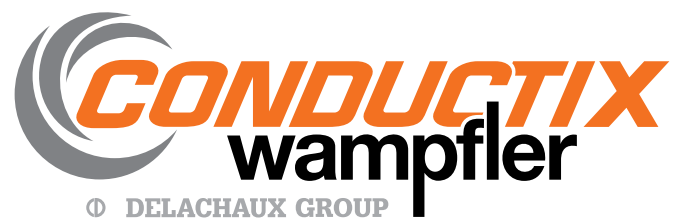

Conductix Incorporated

The technical data and images which appear in this manual are for informational purposes only. **NO WARRANTIES, EXPRESS OR IMPLIED, INCLUDING WARRANTIES OF MERCHANTABILITY OR FITNESS FOR A PARTICULAR PURPOSE, ARE CREATED BY THE DESCRIPTIONS AND DEPICTIONS OF THE PRODUCTS SHOWN IN THIS MANUAL.** Conductix makes no warranty (and assumes no liability) as to function of equipment or operation of systems built according to customer design or of the ability of any of its products to interface, operate or function with any portions of customer systems not provided by Conductix.

Seller agrees to repair or exchange the goods sold hereunder necessitated by reason of defective workmanship and material discovered and reported to Seller within one year after shipment of such goods to Buyer.

Except where the nature of the defect is such that it is appropriate, in Seller's judgment, to effect repairs on site, Seller's obligation hereunder to remedy defects shall be limited to repairing or replacing (at Seller's option) FOB point of original shipment by Seller, any part returned to Seller at the risk and cost of Buyer. Defective parts replaced by Seller shall become the property of Seller.

Seller shall only be obligated to make such repair or replacement if the goods have been used by Buyer only in service recommended by Seller and altered only as authorized by Seller. Seller is not responsible for defects which arise from improper installation, neglect, or improper use or from normal wear and tear.

Additionally, Seller's obligation shall be limited by the manufacturer's warranty (and is not further warranted by Seller) for all parts procured from others according to published data, specifications or performance information not designed by or for Seller.

Seller further agrees to replace or at Seller's option to provide a refund of the sales price of any goods that do not conform to applicable specifications or which differ from that agreed to be supplied which non-conformity is discovered and forthwith reported to Seller within thirty (30) days after shipment to the Buyer. Seller's obligation to replace or refund the purchase price for non-conforming goods shall arise once Buyer returns such goods FOB point of original shipment by Seller at the risk and cost of Buyer. Goods replaced by Seller shall become the property of Seller.

There is no guarantee or warranty as to anything made or sold by Seller, or any services performed, except as to title and freedom from encumbrances and, except as herein expressly stated and particularly, and without limiting the foregoing, **there is no guarantee or warranty, express or implied, of merchantability or of fitness for any particular purpose or against claim of infringement or the like.**

Seller makes no warranty (and assumes no liability) as to function of equipment or operation of systems built to Buyer's design or of the ability of any goods to interface, operate or function with any portions of Buyer's system not provided by Seller.

Seller's liability on any claim, whether in contract, tort (including negligence), or otherwise, for any loss or damage arising out of, connected with, or resulting from the manufacture, sale, delivery, resale, repair, replacement or use of any products or services shall in no case exceed the price paid for the product or services or any part thereof which give rise to the claim. In no event shall Seller be liable for consequential, special, incidental or other damages, nor shall Seller be liable in respect of personal injury or damage to property not the subject matter hereof unless attributable to gross misconduct of Seller, which shall mean an act or omission by Seller demonstrating reckless disregard of the foreseeable consequences thereof.

Seller is not responsible for incorrect choice of models or where products are used in excess of their rated and recommended capacities and design functions or under abnormal conditions. Seller assumes no liability for loss of time, damage or injuries to property or persons resulting from the use of Seller's products. Buyer shall hold Seller harmless from all liability, claims, suits and expenses in connection with loss or damage resulting from operation of products or utilization of services, respectively, of Seller and shall defend any suit or action which might arise there from in Buyer's name - provided that Seller shall have the right to elect to defend any such suit or action for the account of Buyer. The foregoing shall be the exclusive remedies of the Buyer and all persons and entities claiming through the Buyer.

INDEX

- 1.0 Radio Warranty
- 2.0 Safety Considerations
- 3.0 General Operation
- 4.0 Emergency Procedures
- 5.0 Batteries
- 6.0 Receiver Voltage Selection
- 7.0 Changing of Frequency
- 8.0 Wiring

1.0 Radio Warranty

1.1 Warranty

Conductix guarantees that this equipment meets its published specifications at the time of shipment from the factory. This equipment will perform as described if installed properly. However, Conductix cannot guarantee that operation of remote control system is absolutely error-free, or without interruption.

1.2 Warranty Period

This equipment is warranted against defects in materials and workmanship for a period of one (1) year from the date of shipment. During the warranty period, Conductix is responsible for necessary repairs/ replacement as long as the product can be proven defective.

1.3 Warranty Service

For warranty service or repair, this equipment must be returned to Conductix. Customer is responsible for shipping charges to Conductix. Conductix warranty covers only parts and factory labor. No on site in and out charges are covered under this warranty.

1.4 Excluded Parts

This warranty does not include consumable parts such as joysticks, batteries, fuses, buttons, and relays. Also, this warranty does not cover defects caused by improper installation, improper/insufficient maintenance, unauthorized modification, improper operation, ignorance of environmental specifications, and/or improper software/interfaces.

1.5 Remarks

No other warranty is expressed or implied, except for the above mentioned. The remedies provided herein are the buyers' sole and exclusive remedies. Conductix shall not be liable for any direct/indirect, special, incidental, or consequential damage. Consult Conductix general warranty for further information.

2.0 Safety Considerations

2.1 Symbols

2.1.1 Safety Considerations:

Check input voltage **BEFORE** wiring this Protean Unit. Insufficient or overvoltage **WILL** damage unit and **VOID** Warranty.

The default value for AC units is 110v + 10% (99 to 121 VAC). For DC units, the voltage should be 12-24 Volts.

This product and related documentation must be reviewed for familiarization with safety markings and instructions before operation. This product requires strict adherence to instructions in order to ensure operational safety.

2.1.2 Safety Symbols

The following symbols may be found on the remote control or throughout the remote control documentation. Their purpose is to alert you to potentially dangerous situations.



Refer To Manual

When the product is marked with this symbol refer to the instruction manual for additional information.



High Voltage

Indicates presence of hazardous voltage. Unsafe practice could result in severe personal injury.



Protective Earth Ground

Indicates protective earth terminal

2.0 Safety Considerations

2.1 Symbols continued



Warning

Denotes hazard. Included text will give proper instructions. Failure to follow instructions could result in severe personal injury and/or property damage.



Caution

Denotes hazard. Included text will give proper instructions. Failure to follow instructions could result in minor personal injury and/or property damage.



2.2 Warnings

1. Read this manual carefully before operating and installing this product.
2. Due to the complex nature of equipment, it is necessary to read the entire manual before installation.
3. Only authorized personnel should service this equipment. Unauthorized work on this unit will void the warranty.
4. This manual is for reference only; please call your distributor or Conductix if further assistance is required.
5. The equipment has been tested for correct operation before delivery from the factory. However, it must not be used in critical or hazardous operation where incorrect operation may cause personal injury or equipment damage.
6. After daily operation, please shut off main power in crane and the power to the receiver.
7. Transmitter should be placed in a safe place when not in use to avoid accidental pressing of buttons.
8. The crane should be equipped with mainline contactor, limit switches, and other required safety devices as dictated by CMAA, OSHA, or all other applicable governing regulations.
9. Do not use this device during electrical storms or under conditions of electrical interference.
10. Ensure transmitter batteries are in good condition and power for receiver is correct.
11. Installation and maintenance should be done only while the machine's main power and receiver's power are off and locked out to prevent electrical shock.
12. Contents of the manual may be amended by the manufacturer without notice.

3.0 General Operation

- 3.1** Turn on the main power switch of the equipment (Crane).
- 3.2** Install four AA size batteries in the transmitter and make sure the "+" and "-" direction are correct.
- 3.3** Turn the rotary key clockwise to "ON" position, then press the Start pushbutton to Power-On.
- 3.4** Operate normally according to the function setting that has been done.
- 3.5** Please proceed with the following procedure after operation:
 - 3.5.1 Press EMS mushroom and turn the rotary key on the transmitter to "OFF" position to shut off the motion of the receiver and remove the key.
 - 3.5.2 Switch off the main power switch of the equipment (Crane).
 - 3.5.3 Remove the batteries when the equipment is not going to be in use for a long period of time.

3.0 General Operation

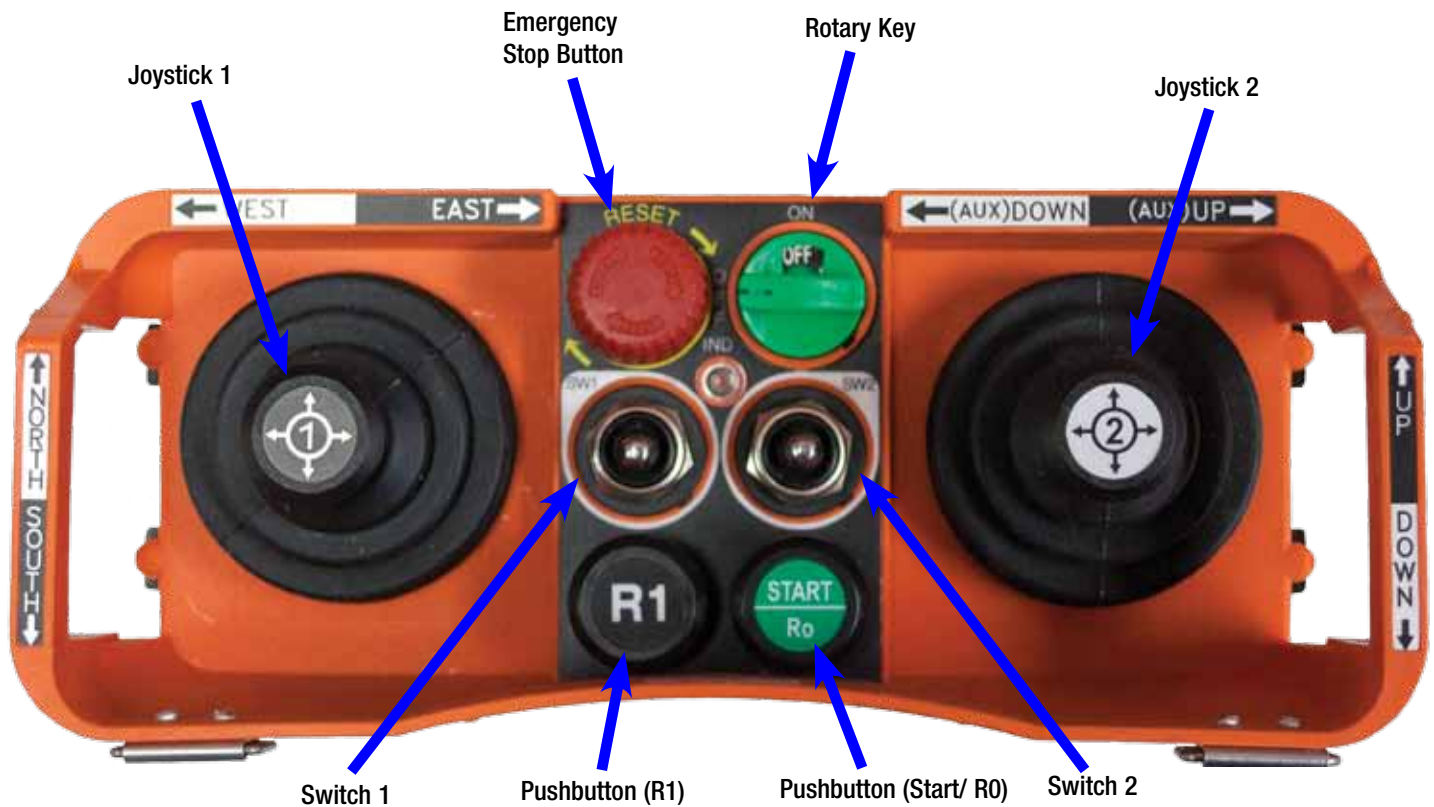

4.0 Emergency Procedures

4.1 In case of any emergency, please follow the steps below and ask the distributor for service immediately:

- 4.1.1 Press EMS Mushroom
- 4.1.2 Turn the rotary key to the "OFF" position.
- 4.1.3 Shut off the main power of the Crane and discontinue operation.
- 4.1.4 Contact the distributor to find out reasons.



5.0 Batteries

- 5.1** Four AA size batteries are required for the transmitter. There is a 3-stage power function with LED display. “Green Color”: Sufficient power to operate transmitter “Yellow color”: Power is depleting. Operation must be stopped immediately (for example: down the goods to ground) to replace batteries. “Red Color”: Insufficient power. Transmitter will send out an emergency stop signal to the receiver due to insufficient power. Operator should avoid this situation in order to maintain the safety of operation.

6.0 Receiver Voltage Selection

- 6.1** There are four input power voltages available for the L-40 as follows:

48/110 VAC (Default)

48/220 VAC

110/220 VAC

220/380 VAC

Please disconnect the RX's power, select the proper voltage and plug in the connector.

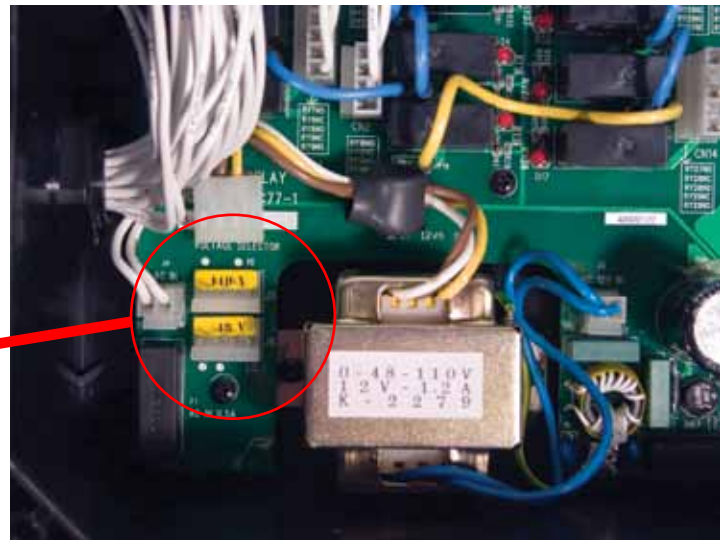

7.0 Changing the Frequency

- 7.1** It is easy to change frequency of the L40 series simply by replacing correspondent frequency crystal in both the TX and RX

Note: To replace a new crystal, please note that there are two kinds of frequencies (VHF and UHF) available. The indication of VHF or UHF is shown on the PC board with a check mark “V” and please make sure not to replace a VHF crystal unit into UHF PC board or vice versa.

- 7.2** Instructions for replacement.

- 7.2.1 Pry up the crystal unit with a flat screwdriver.
- 7.2.2 Remove the crystal unit from the system.
- 7.2.3 Use a needle nose pliers to straighten both pins of the new crystal unit.
- 7.2.4 Insert the new crystal unit vertically into the PC board.
- 7.2.5 Press the new crystal unit down into the socket

7.0 Changing the Frequency

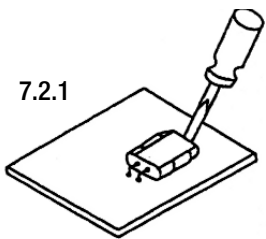
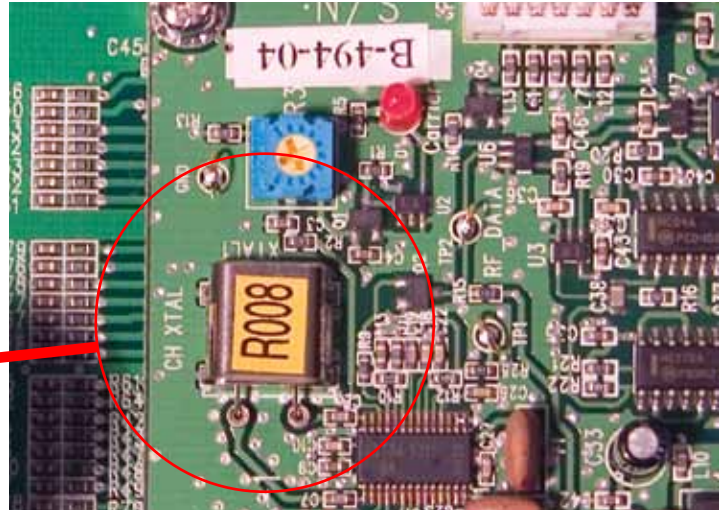

7.2.1

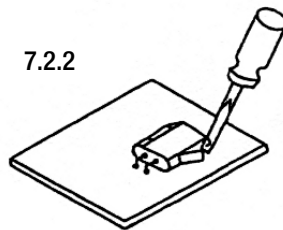

7.2.2

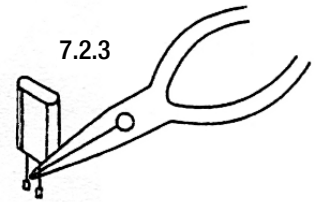

7.2.3

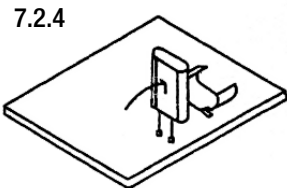

7.2.4

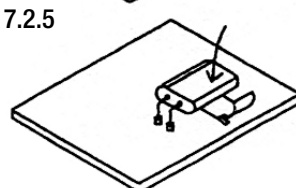

7.2.5

Attention: The frequency will be different when plugging the same crystal into the TX or RX. For example:

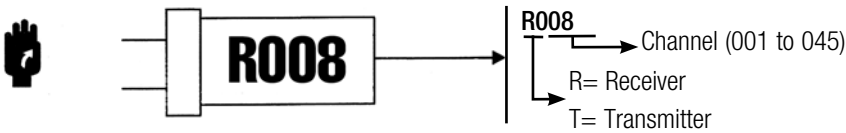

8.0 Wiring

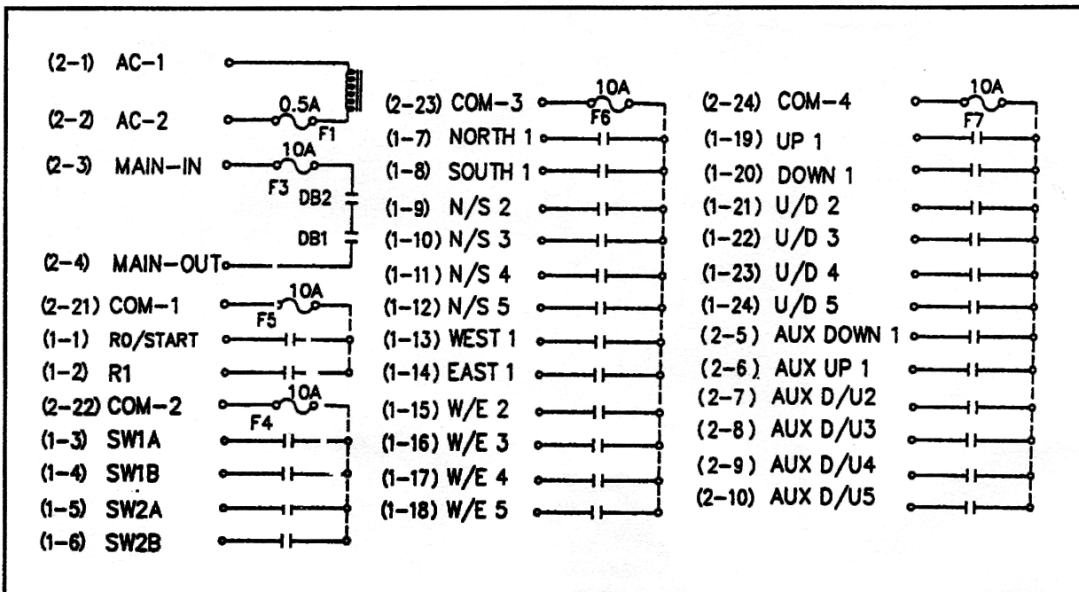

Note: This is the default configuration. Your programming may result in a custom wiring diagram.

Notes

Notes

Notes

www.conductix.us

Conductix-Wampfler

10102 F Street
Omaha, NE 68127
USA

Customer Support
Phone: 800 521 4888
Fax: 800 780 8329

Phone: 402 339 9300
Fax: 402 339 9627

info.us@conductix.com
www.conductix.com

